

# Towards Addressable Wireless Microstimulators Based on Electronic Rectification of Epidermally Applied Currents

L. Becerra-Fajardo – *IEEE Student Member*, and A. Ivorra

**Abstract**— Electrical stimulation has been explored to restore the capabilities of the nervous system in paralysis patients. This area of research and of clinical practice, known as Functional Electrical Stimulation, would greatly benefit from further miniaturization of implantable stimulators. To that end, we recently proposed and demonstrated an innovative electrical stimulation method in which implanted microstimulators operate as rectifiers of bursts of innocuous high frequency current supplied by skin electrodes, thus generating low frequency currents capable of stimulating excitable tissues. A diode could suffice in some applications but, in order to broaden the method’s clinical applicability, we envision rectifiers with advanced capabilities such as current control and addressability. We plan flexible thread-like implants (diameters < 300  $\mu\text{m}$ ) containing ASICs. As an intermediate stage, we are developing macroscopic implants (diameters  $\sim 2$  mm) made of off-the-shelf components. Here we present a circuit which responds to commands modulated within the high frequency bursts and which is able to deliver charge-balanced currents. We show that a number of these circuits can perform independent stimulation of segments of an anesthetized earthworm following commands from a computer.

## I. INTRODUCTION

Among other medical uses, electrical stimulation is used for restoration of muscle function in paralysis patients; an area of research and of clinical practice known as Functional Electrical Stimulation (FES). This requires applying electric currents in the vicinity of motor nerves through electrodes by means of a pulse generator. Coarsely, therapeutic electrical stimulation systems can be classified into two main categories according to the location of the electrodes and the generator: surface systems and implantable systems. Surface systems are considered as non-invasive but, among other drawbacks, they lack enough selectivity. When spatial selectivity is required (e.g. to target specific nerves or to avoid stimulation of subcutaneous pain receptors), fully implantable systems are largely preferred. In this case, both the generator and the electrodes are implanted within the patient’s body. This approach implies that the generators must be biocompatible and contained in a hermetic package. In addition, these devices should be minimally invasive, which frequently means minimal dimensions, and should be implantable by means of simple surgical procedures [1].

Currently, implantation of most electrical stimulation systems requires complex surgeries which hamper their use

L. Becerra-Fajardo (corresponding author) and A. Ivorra are with the Dept. of Information and Communication Technologies of the Universitat Pompeu Fabra, Barcelona, Spain (phone: +34-93-542-1578; fax: +34-93-542-2517; e-mail: [laura.becerra.fajardo@gmail.com](mailto:laura.becerra.fajardo@gmail.com)).

in diverse clinical scenarios. That is the case of movement restoration: available implantable systems consisting of central stimulation units wired to the stimulation electrodes are not adequate for applications in which a large number of targets must be individually stimulated over large and mobile body parts, thus hindering solutions for patients suffering paralysis due to spinal cord injury or other neurological disorders. An alternative to centralized stimulation systems could consist in developing a network of addressable single-channel wireless microstimulators which could be implanted with simple procedures such as injection, and which would be activated in coordinated patterns by an external automated controller. In fact, such solution was proposed and tried in the past [2]. However, previous attempts in this direction did not achieve satisfactory success as the developed implants were stiff and too large or, in other words, too invasive. Further miniaturization was prevented because of the use of inductive coupling and batteries as energy sources.

## II. PROPOSED METHOD FOR ELECTRICAL STIMULATION

In [3] we proposed and in vivo demonstrated an alternative method for performing electrical stimulation by using electronic implants: the implanted devices rectify bursts of innocuous high frequency (HF) (e.g. 1 MHz) currents conductively supplied to the tissue of interest by remote electrodes so that low frequency (LF) currents are generated locally through the implants. These resultant LF currents are capable of stimulating local excitable tissues whereas the HF auxiliary currents are inert. This idea is schematically illustrated in Fig. 1. In [4] we showed that the HF bursts are indeed innocuous, both in terms of heating and unintended electro-stimulation, and that portable systems will be feasible with present battery technologies (Fig. 2).

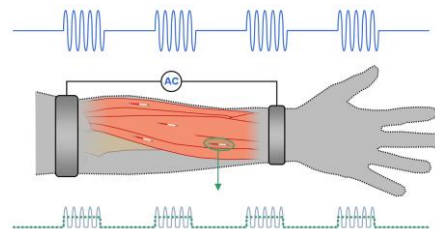

Figure 1. In the proposed method the implants rectify innocuous AC current bursts, which are applied through external electrodes, thus generating current densities of low frequency capable of locally stimulating tissue.

In comparison to inductive coupling, or to electrochemical batteries, this method offers an unprecedented potential for miniaturization. Note that only two peripheral electrodes are required both for picking-up the HF currents and for performing stimulation. In addition,

all necessary electrical components, maybe with the exception of the electrodes, can be integrated in a single integrated circuit or in a tiny hybrid microcircuit.

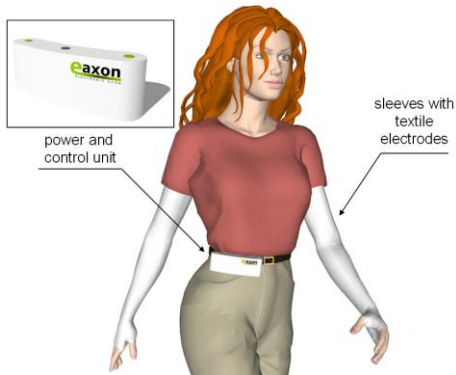

Figure 2. This is how we envision the external appearance of a possible neuroprosthesis based on the proposed method. The auxiliary HF currents would be provided through textile electrodes from a portable system.

The proposed method requires a minimum voltage drop to operate and this implies that, in most applications, it will be necessary that both electrodes are quite separated (from some millimeters to a very few centimeters). Consequently, we propose elongated implant bodies in which most of their length consists of flexible and stretchable materials whose mechanical properties match those of neighboring living tissues. The implants may look like short pieces of flexible and stretchable thread. Because of such feature, and because of their intended functionality, we coined the name “Electronic Axons” (eAXONs) for these implants. We envision ultrathin eAXONs (diameter < 300  $\mu\text{m}$ ) with advanced communication, control and sensing capabilities which will be percutaneously deployed in large numbers thus forming a complex network controlled by an external autonomous unit which delivers the innocuous HF currents. These systems will be capable of executing complex stimulation patterns such as those that would be required for fine movement restoration in paralysis patients.

It is worth noting that in the 60s and 70s the idea of using implanted diodes for electrical stimulation was first explored by at least two independent research teams [5][6]. However, this concept was not pursued any further and no advanced rectifiers have been proposed until now. One possible explanation for such neglect is that microelectronics was starting to emerge at that time period, and so, the coils and batteries were not the miniaturization bottleneck but the electronics.

The advanced ultrathin eAXONs to be created will require future development of Application Specific Integrated Circuits (ASICs) and specific packaging and interconnection techniques. Meanwhile, we are working on the development of relatively thick eAXONs made of off-the-shelf components on a rigid-flex PCB encapsulated within a silicone tubular body (Fig. 3). These thick eAXONs will be about 3 cm long and will have a diameter of about 2 mm.

Here we present a circuit architecture for the thick eAXONs which responds to commands modulated within the

high frequency bursts and which is able to deliver charge-balanced currents. Two main constraints were particularly taken into account during its design: the number of electronic components and interconnections had to be minimized, and off-the-shelf components with footprints smaller than 2 mm had to be chosen.

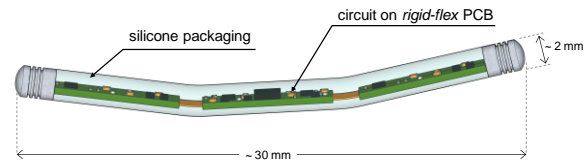

Figure 3. Semiflexible thick eAXON under development.

We also show that a number of these circuits connected to electrode pairs hooked to an anesthetized earthworm can perform independent stimulation of segments of the earthworm following commands from a computer.

### III. PROPOSED CIRCUIT ARCHITECTURE

The proposed circuit is depicted in Fig. 4. Six main elements or blocks can be identified: 1- the two electrodes, which are used both for picking-up the high frequency AC current that flows through the tissues by conductive coupling and for delivering the LF stimulation currents, 2- a full-bridge rectifier and a regulation subcircuit, which are in charge of electrically feeding the control unit and the current sources, 3- two switchable current sources able to generate biphasic currents, 4- the control circuit (a microcontroller), 5- an amplitude-shift keying (ASK) demodulator and 6- a DC-blocking capacitor for preventing electrochemical damage to tissues and the electrodes when perfect charge balance is not achieved by means of biphasic stimulation (due to possible mismatches).

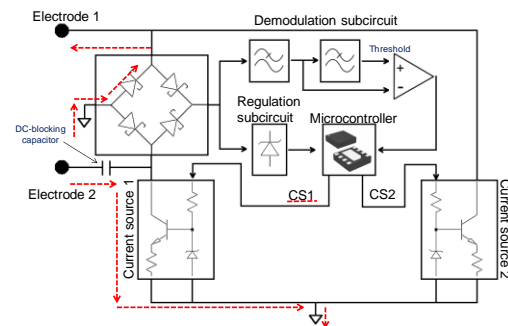

Figure 4. Proposed circuit architecture for the thick eAXONs. The dashed line shows the flow of the rectified current when the control signal 1 (CS1) activates the current source 1.

The system is governed by one of the smallest microcontrollers commercially available: the ATtiny10 by ATMEL Corp., a 8-bit microcontroller with a footprint of 2 mm  $\times$  2 mm.

Commands are transmitted from the external system by means of amplitude-shift keying (Manchester coding) at a rate of 20 kbauds on a 1 MHz sinusoidal current. Those commands include the address of the stimulator to be activated and the pulse width of the cathodal phase. As shown in Fig. 4, the ASK demodulator simply consists of

two low-pass filters and a comparator: a filtered signal (cutoff frequency =  $f_{C1}$ ) fixes a threshold that is compared to a second filtered signal ( $f_{C2} > f_{C1}$ ). The result of this comparison is a ‘high’ or a ‘low’ digital level that is captured by the microcontroller

The HF current burst consists of three stages: 1- start-up time for the microcontroller’s power up, 2- bit stream, including synchronization bits for the communication link and data stream, and 3- stimulation stage, when the microcontroller generates the control signals for cathodic and anodic currents. In order to avoid the start-up time (80 ms) at every HF current burst, the sleep mode is enabled after the first burst; the bit streams and stimulation stages of next bursts of HF current wake up the microcontroller and provide enough charge to the capacitor at the regulation sub-circuit (15  $\mu$ F) so as to prevent the microcontroller to shut-down. That is, the time consuming power-up is only performed in the initial burst.

Communications and control operate when the peak voltage of the HF burst between the electrodes is higher than 5.5 V (absolute maximum peak voltage = 15 V).

In order to minimize tissue heating, which is proportional to the square of current density and to the time, the HF current burst amplitude typically will not be constant: minimum amplitude (for guaranteeing 5.5 V drop at the electrodes) will be employed during the start-up and bit stream stages whereas much higher amplitudes will be delivered during the stimulation stage for guaranteeing voltage compliance of the current sources.

Most implantable stimulators make use of the so-called charge-balanced current waveforms. These waveforms consist of a cathodic (negative) current phase followed by an anodic (positive) current phase which is characterized by compensating the injected charge during the cathodal phase. That is, it is intended that the injected net charge is zero. This minimizes electrochemical damage both to the electrodes and to the tissues [7]. Here we have adopted this strategy by implementing two independent current sources which enable the generation of low frequency symmetrical biphasic currents. However, when two independent current sources are employed for generating the cathodic and anodic currents, mismatches may impede proper charge balance unless other mechanisms are implemented. In this case, we employ a DC-blocking capacitor of 10  $\mu$ F that passively discharges through the implant and the tissues when no bursts are applied.

The basic structure of the current sources is displayed in Fig. 4. A zener diode fixes a voltage at the base of an NPN transistor, which in turn fixes a voltage in the emitter of the transistor, therefore defining a current flowing from the emitter to the resistor and ground. Similar current sources have been used in the past in other FES systems [8], and their architecture satisfies the main constraints for the circuit’s design: few electronic components and small footprints. It must be noted that through this structure a half-rectified HF current circulates. Therefore, rather than acting as a true current source, the structure is acting as a peak current limiter for the HF current. Nevertheless, in terms of

the low frequency components generated by rectification, this structure can be seen as a LF current source.

## IV. DEMONSTRATIONS

### A. Electronic demonstration

Circuit prototypes have been implemented on rigid PCBs (dimensions 50 mm  $\times$  50 mm) for test purposes. The prototypes were made with relatively large off-the-shelf components for which packaged versions exist with footprints smaller than 2 mm.

The external system electronics consisted of a signal generator (function generator AFG3022 by Tektronix and ACQ board NI-USB6216 by National Instruments) and a high-voltage amplifier (WMA-300 by Falco Systems). A LabVIEW virtual instrument running in a PC generated the modulating signal (NI-USB6216) which modulated the 1 MHz carrier signal (generated by the AFG3022). A graphic user interface in the virtual instrument defined the address of the implant to be activated, and triggered the corresponding bursts of high frequency AC current.

The setup shown in Fig. 5 was built in order to demonstrate the capability of the system to electrically feed the electronics of the implantable device, and accomplish controlled current injection. The proposed circuit is drawn in black while a simplified circuit corresponding to the rest of the system (i.e. external generator and tissue impedances) is drawn in gray. Nodes E1 and E2 represent the electrodes of the circuit. Their impedances are neglected for simplicity. The resistors’ values were chosen to coarsely represent tissue impedances for a 3 cm eAXON in muscle tissue according to simulations (not reported here).

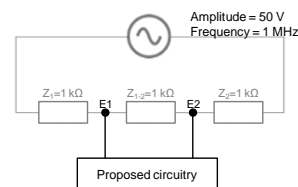

Figure 5. Setup used to demonstrate and evaluate the generated low frequency currents.

Fig. 6 shows the results obtained with this setup when HF bursts were transmitted so as to generate biphasic symmetric current pulses of 500  $\mu$ s at a rate of 20 Hz. The control signal 1 (CS1) activates for 500  $\mu$ s the current source 1, generating a cathodic current. An interphase dwell is generated between phases, and an anodic current is generated for 500  $\mu$ s when the control signal 2 (CS2) activates current source 2. The presence of the interphase dwell is considered to be beneficial in terms of stimulation effectiveness [9].

The low frequency components of the current flowing through the circuit were obtained by capturing, with a battery powered oscilloscope (TPS2014 by Tektronix), the voltage drop across the parallel combination of a 10  $\Omega$  resistor and 2.2  $\mu$ F capacitor (RC low pass filter, cutoff frequency = 7.2 kHz).

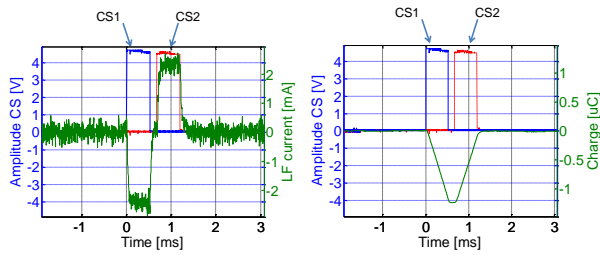

Figure 6. Low frequency current and its corresponding charge when the system applied a cycle of cathodic and anodic current pulses. The control signals (CS1 and CS2) govern the behavior of the current sources.

As it can be observed in Fig. 6, the implemented current sources generate a low frequency current peak value of 2.4 mA in the cathodal and anodal phase, which is enough to electrically stimulate nerves [10].

The calculated charge displayed in Fig. 6 shows that the circuit was able to inject over 1.2  $\mu\text{C}$  in the cathodal phase of the stimulation and that this charge was balanced during the anodal phase.

### B. In vivo demonstration

In order to demonstrate the capability of the proposed circuit, and of the whole method, for performing independent electrical stimulation of excitable tissues, we carried out short experiments with anesthetized earthworms (Large *Dendrobaena* sp., immersed in a 0.2% tap water solution of Chlorobutanol for 10 minutes).

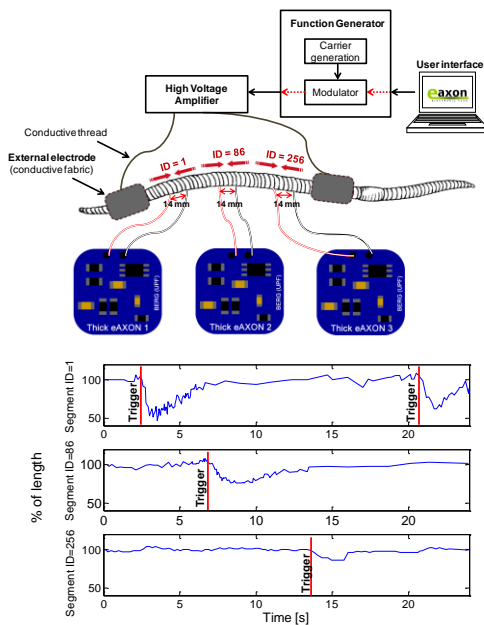

Figure 7. In vivo setup and quantitative data. The circuits are commanded from a computer. Each device produces a small contraction in a segment of the earthworm when the stimulation is enabled. The quantitative data corresponds to video analysis of an experiment (see text).

The setup for these *in vivo* tests is schematically represented in Fig. 7. Textile electrodes made of conductive fabric (MedTex130, manufactured by Statex Produktions & Vertriebs GmbH, Bremen, Germany), which is based on silver-plated nylon and has a surface resistivity  $< 1 \Omega/\text{in}^2$ ,

were attached to both ends of the earthworm, and were connected to the external system using conductive thread. (These materials were chosen in order to demonstrate the feasibility of the concept depicted in Fig. 2.) Three circuit prototypes were programmed with randomly defined addresses and three pairs of wires (copper - kynar 30 AWG, model 100-30 by Pro-Power a value brand of Farnell) were plunged into the earthworm (acting as electrodes) and each pair was connected to a circuit prototype. Activation of each one of the circuit prototypes was triggered from the graphic user interface.

Video 5 in <https://sites.google.com/site/electronicaxons> reproduces one of the experiments performed with the above setup. Using a video motion analysis software [11], the contraction of each segment was quantitatively assessed (Fig. 7).

The experiments did indeed show that it was possible to selectively induce contraction of each earthworm's segment when the corresponding address of a single stimulator was defined and the stimulation was triggered in the graphic user interface.

### ACKNOWLEDGMENT

AI's research is supported by a Ramón y Cajal fellowship from the Spanish government and a Marie Curie grant (IRG 256376) from the European Commission. LBF's research is supported by a scholarship from the UPF.

### REFERENCES

- [1] P. H. Peckham and D. M. Ackermann, "Chapter 18 - Implantable Neural Stimulators," in *Neuromodulation*, San Diego: Academic Press, 2009, pp. 215–228.
- [2] J. H. Schulman, "The Feasible FES System: Battery Powered BION Stimulator," *Proc. IEEE*, vol. 96, no. 7, pp. 1226–1239, 2008.
- [3] A. Ivorra, "Remote Electrical Stimulation by Means of Implanted Rectifiers," *PLoS One*, vol. 6, no. 8, p. e23456, 2011.
- [4] A. Ivorra and L. Becerra-Fajardo, "Wireless Microstimulators Based on Electronic Rectification of Epidermally Applied Currents: Safety and Portability Analysis," in *18th IFEES Annual Conference*, 2013, pp. 213–216.
- [5] Y. Palti, "Stimulation of internal organs by means of externally applied electrodes," *J Appl Physiol*, vol. 21, no. 5, pp. 1619–1623, Sep. 1966.
- [6] J. C. Schuder and J. H. Gold, "Localized DC field produced by diode implanted in isotropic homogeneous medium and exposed to uniform RF field.," *IEEE Trans. Biomed. Eng.*, vol. 21, no. 2, pp. 152–63, Mar. 1974.
- [7] S. F. Cogan, "Neural Stimulation and Recording Electrodes," *Annu. Rev. Biomed. Eng.*, vol. 10, no. 1, pp. 275–309, 2008.
- [8] M. Ilic, D. Vasiljevic, and D. B. Popovic, "A programmable electronic stimulator for FES systems," *IEEE Trans. Rehabil. Eng.*, vol. 2, no. 4, pp. 234–239, 1994.
- [9] T. G. Constantinou, J. Georgiou, and C. Toumazou, "A partial-current-steering biphasic stimulation driver for vestibular prostheses.," *IEEE Trans. Biomed. Circuits Syst.*, vol. 2, no. 2, pp. 106–13, Jun. 2008.
- [10] A. R. Sauter, M. S. Dodgson, H. Kalvøy, S. Grimnes, A. Stubhaug, and Ø. Kjaastad, "Current Threshold for Nerve Stimulation Depends on Electrical Impedance of the Tissue: A Study of Ultrasound-Guided Electrical Nerve Stimulation of the Median Nerve," *Anesth. Analg.*, vol. 108, no. 4, 2009.
- [11] J. K. Barraclough, "PhysMo - Video Motion Analysis." 2011.